

TECHNISCHE DATEN

ROLF BENZ 310



**ROLF
BENZ**

- Holz-Innengestell
- Stahlwellen-Unterfederung
- Rücken aus Polyurethanschaum
- Sitz aus Polyurethanschaum, schichtweise aufgebaut in verschiedenen Höhen und Härten aufeinander abgestimmt
- Bezug mit Polyester-Vlies untersteppt
- Spange Metall, wahlweise:
 - Edelstahl
 - Stahl glatt pulverbeschichtet matt RAL 9017 Verkehrsschwarz

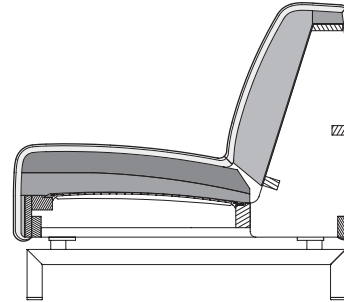

! Hochwertiger, legerer Polsteraufbau mit warentypischer Bildung von Wellen/Sitzabdrücken. Alle Maße sind Zirka-Angaben.

Sitzhöhen lieferbar

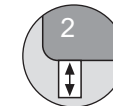

Sofabank

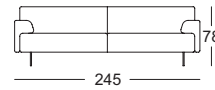
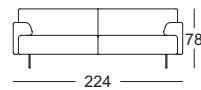
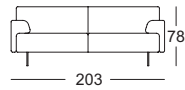
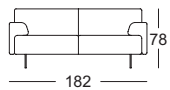

**ROLF
BENZ**

Anreihsofa*

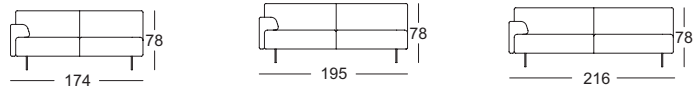

Eck-Anreihsofa*

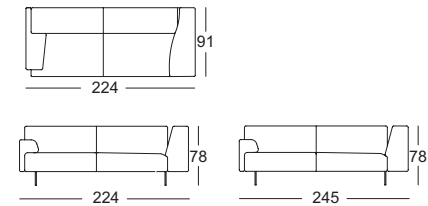

Eck-Anreihbank*

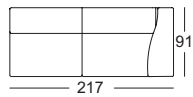

Anreihbank mit Polstersitz*

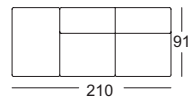

Eck-Anreihbank mit Polstersitz*

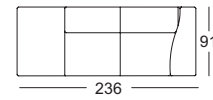

Polsterbank

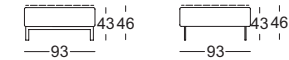
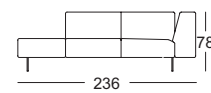
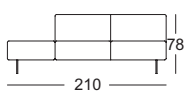
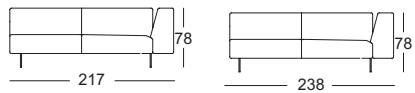
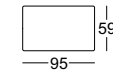

Kombinationsbeispiele:

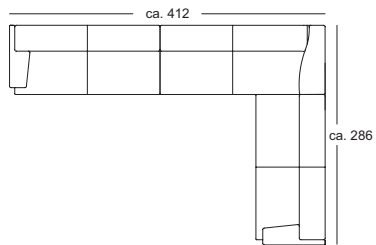

ASO 310/195 li.
E-ARB 310/217 li.
ASO 310/195 re.

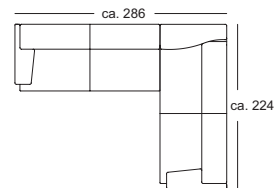

ASO 310/195 li.
E-ASO 310/224 re.

*Diese Elemente sind in ihrer linken Ausführung abgebildet. Sie sind aber auch gespiegelt in der rechten Ausführung verfügbar.